

性能:

额定电流: 2.0A
 额定电压: 12V
 耐电压: 500V
 接触电阻: 30mΩ
 绝缘电阻: 500MΩ
 工作温度: -40℃~+85℃
 使用寿命: 5000次以上
 塑件(材质): LCP(黑色) UL94-V0
 接触点(材质): 锡磷青铜, 触点镀金3U",
 焊脚镀金1U", 镍30-80U"
 固定片(材质): 黄铜C2680,
 镀全雾锡70U"以上, 镍底30-80U"
 环保要求: 符合ROHS限值。

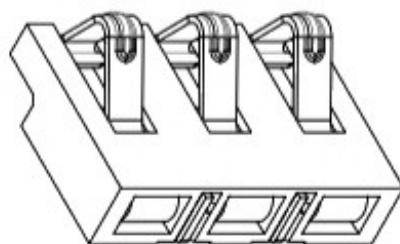

PUSH DIRECTION

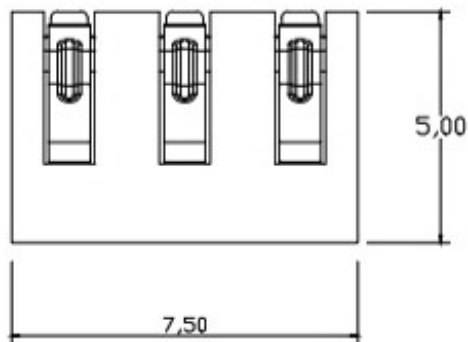
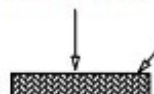

BATTERY

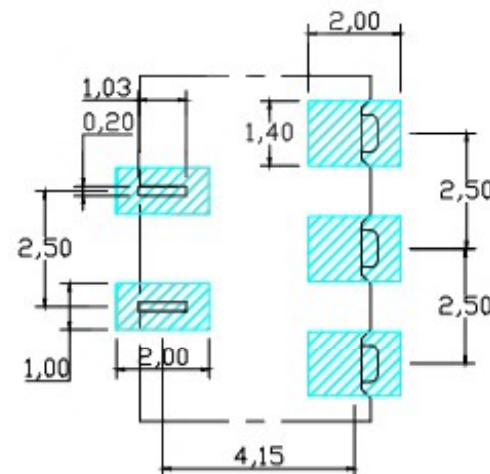
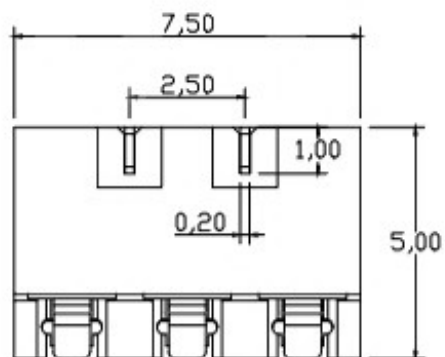
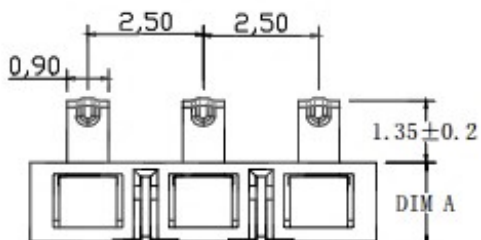
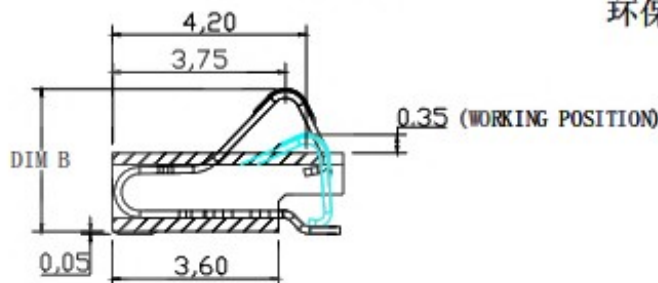

RECOMMENDED PCB LAYOUT

TOP VIEW (. XX±0.05)

PART NO.	DIM A	DIM B
BC3P25H305	1.7	3.05±0.2
BC3P25H335	2.0	3.35±0.2

PART NAME		CONNECTOR		DRAWING	Y.C,ZHANG	DWG.No.	SBICL
PART NO.				CHECK	G.C.Chen	REV.	A1
UNIT : mm	TOLERANCE	UP TO 5	±0.2	APPROVAL		DATE	23-08-2019
	OTHERWISE	ABOVE 5~30	±0.3			ANGLE	0°±3'
				SCALE	2:1		