

说明:

1. 胶芯: LCP 黑色; UL94V-0.
2. 端子: C2680 T=0.15mm, 半金镍1u" (镀层)
3. 外壳: SUS304 T=0.25mm, 镀镍
4. 额定电流: 1 A 最大.
5. 耐电压: 100V(AC) /1分钟 至少.
6. 接触阻抗: 50mΩ 最大.
7. 绝缘阻抗: 100MΩ 最小.
8. 插入力: 3.57 Kgf 最大.
9. 拔出力: 1.0 Kgf 初始 最小; 测试后 0.81 Kgf 最小
10. 温度范围: -30°C~+80°C

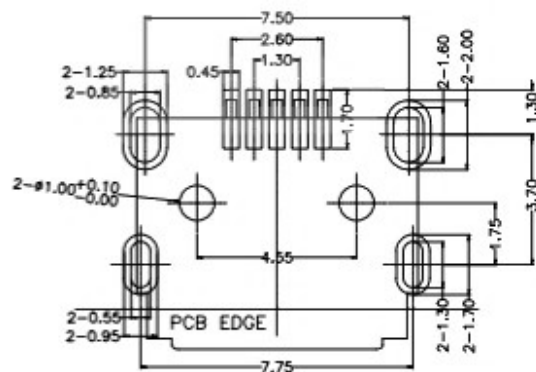

RECOMMENDED PCB LAYOUT
TOL:±0.10(TOP VIEW)

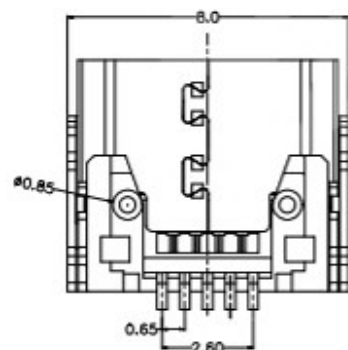
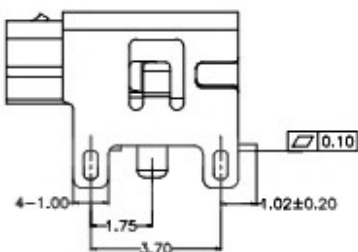
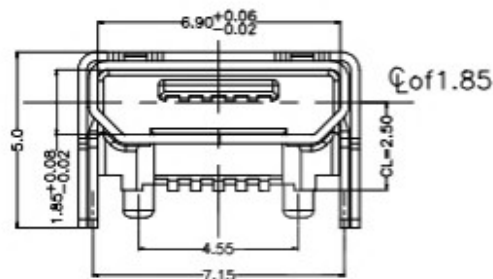
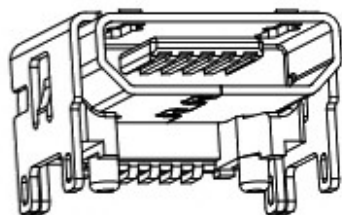
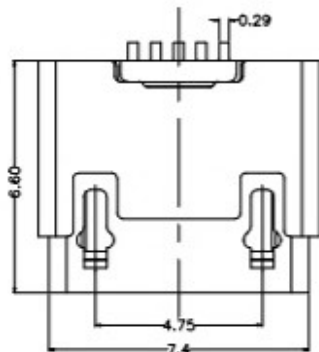
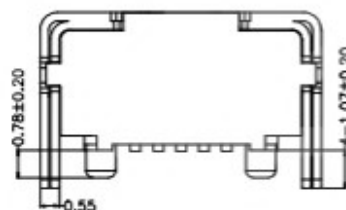

④	CONTACT	----	5	Copper Alloy T=0.20	Au/Sn Plated, Ni Under plated
③	SHELL	----	1	Stainless Steel T=0.25	Ni/Cu PLATED
②	COVER	----	1	Stainless Steel T=0.25	Ni/Cu PLATED
①	HOUSING	----	1	LCP	Block, UL94V-0
NO	PART	P/N	NUM	MATERIAL	MARK