

Model No.	PJ-3612	PJ-3613	PJ-3614	PJ-3615
Schematic				

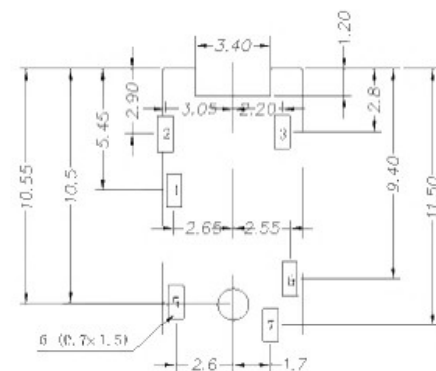

P. C. B LAYOUT TOP VIEW

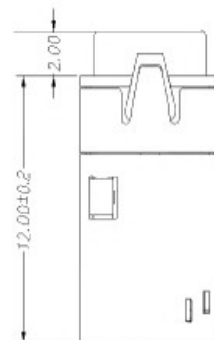
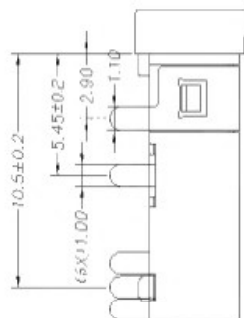
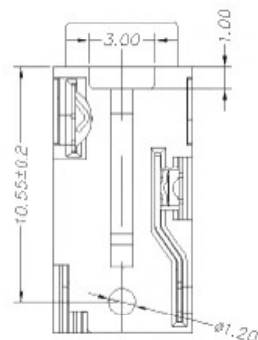
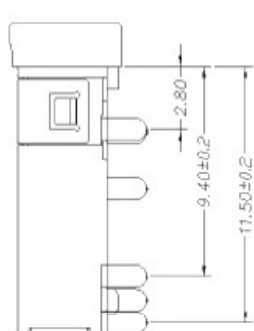
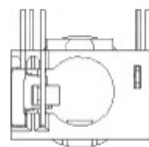
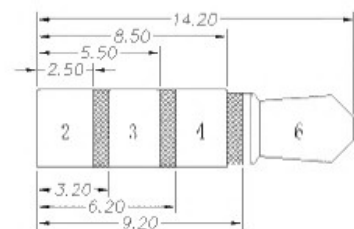

	MATERIAL	PLATING
terminal 2	Phosphor Bronze	tin
terminal 3	Phosphor Bronze	tin
terminal 4	Phosphor Bronze	tin
terminal 5	Phosphor Bronze	tin
terminal 6	Phosphor Bronze	tin
terminal 7	Phosphor Bronze	tin
plastic	Pbt	

MARK	DESCRIPTION	DATE	REVISED	APPROVED	ANGLAR	±5°	DSND	DATE	SCALE: N/A	MODEL TYPE: 3.5 PHONE JACK		
Δ X					X.X	±0.2mm	DWN	DATE	VIEW:	PART NO.:		
Δ X					X.XX	±0.1mm	CHKD	DATE	UNIT: mm	DWG NO.:		
Δ X					X.XXX	±0.05mm	APPD	DATE	SIZE: A4			
REVISIONS						UNSPECIFIED TOLERANCES	东莞市溪榜电子有限公司			WEIGHT 1.0g	SHEET 1/1	REVISION A0