

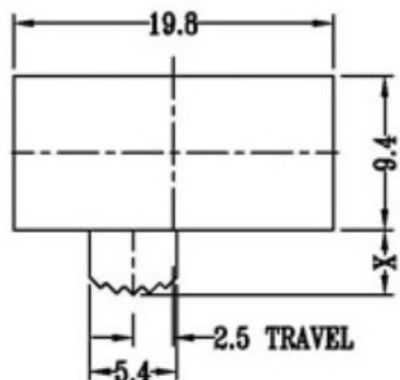

CAD FILE:

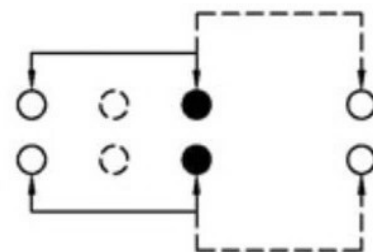

X=3-12
单位: mm

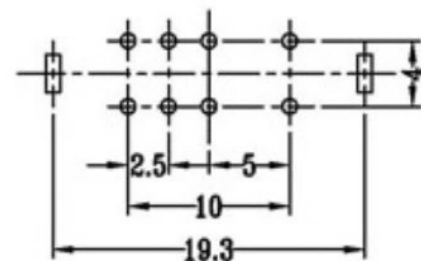
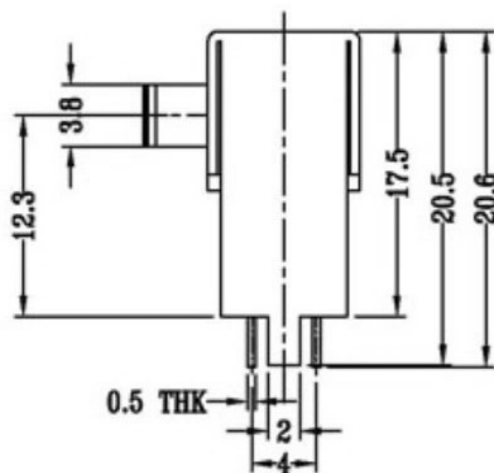
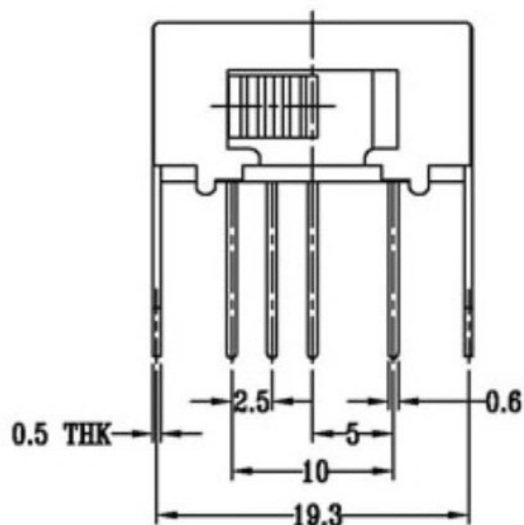

SCHEMATIC (SHORTING)

P.C.B LAYOUT
BOTTOM VIEW

注: "*"表示关键尺寸(6个)

NO.	PARTS	MATERIALS	QTY	FINISH	TOLERANCE UNLESS SPECIFIED	ISSUE	DATE	DESCRIPTIONS OF REVISION	APPD
8									
7	STEEL BALL	STEEL	1	NATURAL					
6	SPRING	STEEL WIRE	1	NATURAL					
5	CONTACT CLIP	PBS STRIP	2	Ag PLATED	WITHIN	A	2012-12-25	初板	
4	TERMINAL	BRASS STRIP	10	Ag PLATED	OVER				
3	BASE	PHENOLIC RESIN	1	BLACK	TITLE: HORIZONTAL SLIDE SWITCH		UNIT : mm	DRWG NO.:	
2	FRAME	STEEL STRIP	1	Ni PLATED	MODEL:		SCALE: 2:1	DWN	2012-12-25
1	KNOB	POM	1	BLACK	东莞市溪榜电子有限公司		CHK'D		2012-12-25
							APPD		2012-12-25