

Note:

1.Material:

- 1.1 Housing: lcp
- 1.2 Contact:C5191,t=0.20mm
- 1.3 InnerShell: LCP
- 1.4 OutShell: SUS304

2.ELECTRICAL:

- 2-1:CURRENT RATAING:
VBUS AND GND CONTACTS RATED AT 1.5A
PARALLELED FOR A TOTAL OF 3A;
- 2-2:INITIAL CONTACT RESISTANCE :40 MEGOHMS
- 2-3:DIELECTRIC WITHSTANDING VOLTAGE:
100V AC MIN;

3:MECHANICAL CHARACTERISTICS:

- 3-1:MATING FORCE:5~20N
- 3-2:UNMATING FORCE:8~20N(INITIAL),
6~20N(AFTER 10000 CYCLES)
- 3-3:FREQUENCE: 200±50 CYCLES /HOUR,10000 CYCLES
- 3-4:OPERATING TEMPERATURE ;-40°~80°.

4: WATERPROOF: IPX7.

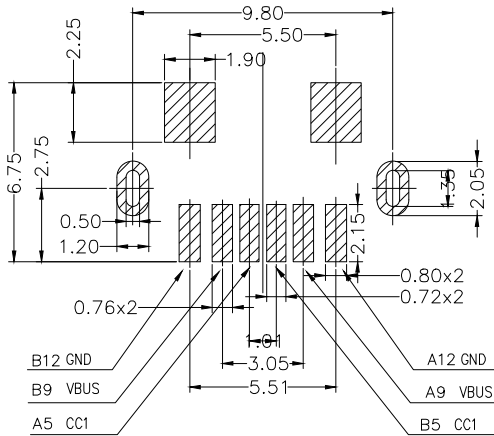
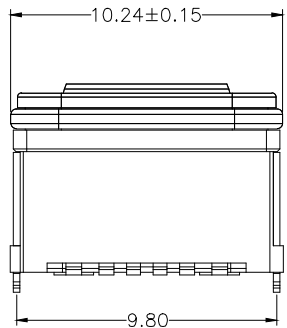
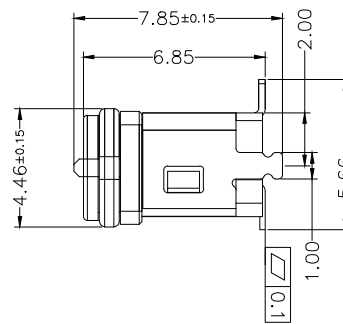
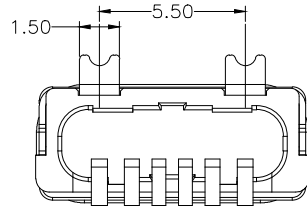
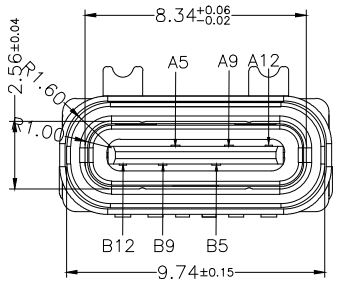

PCB LAYOUT 图仅供参考

防水圈

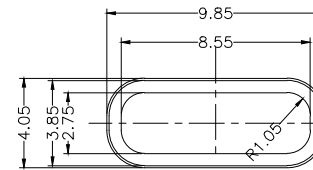

Capdimensions

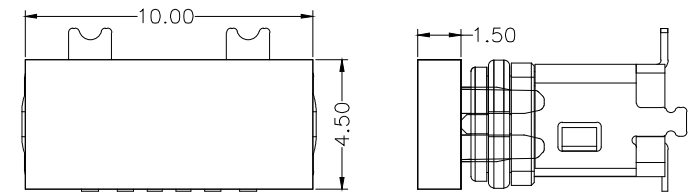

TABLE B

A5	CC1	B12	GND
A9	VBUS	B9	VBUS
A12	GND	B5	CC2
PIN	SIGNAL NAME	PIN	SIGNAL NAME

东莞市溪榜电子有限公司
DONG GUAN XIBANG ELECTRONICS CO., LTD.

TOLERANCE: X.X ±0.30 X.XX ±0.20 X.XXX ±0.10 X.XX ±0.10 X.X ±0.05 X.X ±0.05 X.X ±0.05	DRAWN BY :	DATE :	PART NAME:	
			2015.08.18	TYPE-C6P防水立式贴板全塑H6.8
	CHECKED BY :	DATE :	2015.08.18	PART NO.
	APPROVED BY :	DATE :	2015.08.18	MOLD NO.
UNIT: mm [inch] SCALE:1:1 SIZE: A4			DRAW NO:	
			SHEET NO.	1 OF 1