

备注 (NOTE):

1. 材质:

- 1-1. 塑胶: PA9T 黑色UL94V-0, 符合环保.
- 1-2. 端子: C2680-H T, 镀半金雾锡1U".
- 1-3. 外壳: SUS201-1/2H 镀镍48H, 符合SGS环保.

2. 尺寸标注事项:

- 2-1. 图示有标注"▲"记号者为重点尺寸.
- 2-2. 图示所有标注"*"尺寸为首样全检尺寸.
- 2-3. 图示所有标注"Cpk"尺寸为Cpk检验尺寸.

3. 电气特性:

- 3-1. 接触区: 接触电阻40mΩ Max, 允许10mΩ变化量. 测试条件: 20mv, 100mA下测量.
- 3-2. 接触电流: 3A VBUS引脚; 1.25A用于GND引脚; 其他引脚为0.25A.
- 3-3. 额定电压: 30V.
- 3-4. 耐电电压: 100VR. M. S.
- 3-5. 绝缘电阻: 至少100兆欧.

4. 机械性能:

- 4-1. 插入力: 0.51-2.04Kg, 拔出力: 0.51-2.04Kg
- 4-2. 插拔次数: 10000次.
- 5. 工作环境: -20°C to +85°C.

6. 测试要求:

- 6-1. 吃锡测试: 95%, 盐雾测试: 24HR MIN.

7. 品质要求事项:

- 7-1. 产品表面不能刮伤, 划伤压痕, 缺胶, 歪PIN, 起气泡.
- 7-2. 镀层要均匀, 不能有发黑发白及露铜现象.

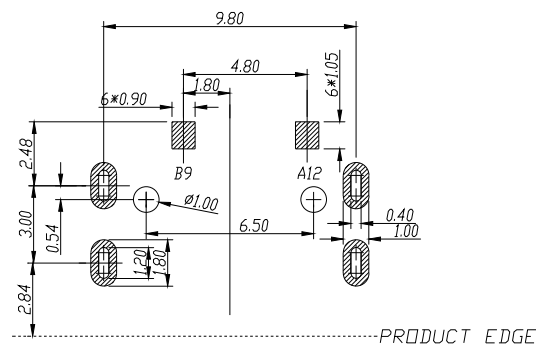
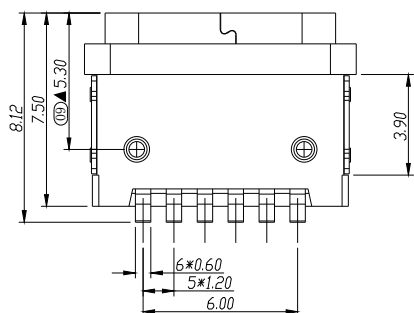
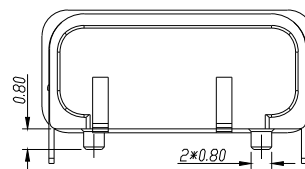
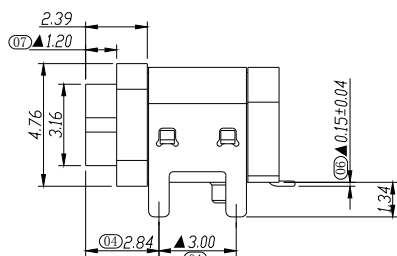
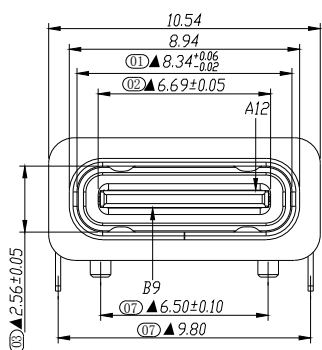
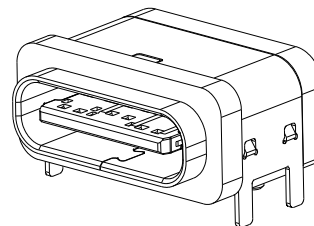
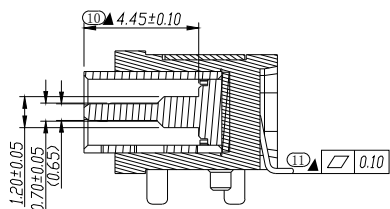
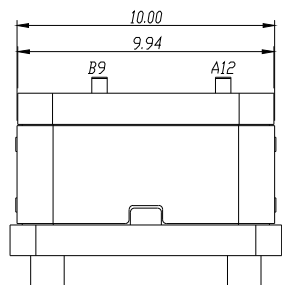

RECOMMENDED PCB LAYOUT (TOP VIEW)
THICKNESS 0.8±0.10MM; DEFAULT TOLERANCE: ±0.05

A12	A11	A10	A9	A8	A7	A6	A5	A4	A3	A2	A1
GND											
								VBUS			
B1	B2	B3	B4	B5	B6	B7	B8	B9	B10	B11	B12

东莞市溪榜电子有限公司
DONG GUAN XIBANG ELECTRONICS CO., LTD.

TOLERANCE: X.XX ±0.30 X.XXX ±0.20 X.XXX ±0.10 X.X ±0.10 X.X ±0.05	DRAWN BY :	DATE :	PART NAME:	
			TYPE-C2P防水四脚前插后贴L7.5	
 UNIT: mm [inch] SCALE: 1:1 SIZE: A4	CHECKED BY :	DATE :	PART NO.	SEE TABLE
	APPROVED BY :	DATE :	DRAW NO.	
			SHEET NO.	1 OF 1