

# 东莞市溪榜电子有限

PB07

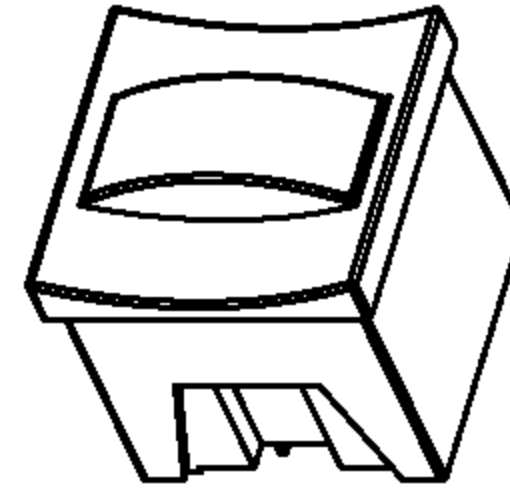
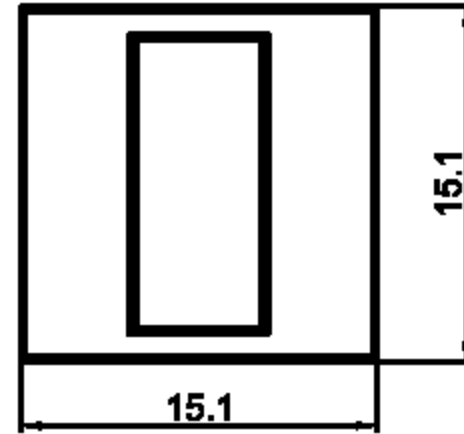

Rating: 100mA 30VDC ;  
 Contact Resistance: 100mΩ Max. ;  
 Insulation Resistance:DC 500V 100MΩ Min. ;  
 Dielectric Strength:AC 250V 1 minute  
 Total Travel: 2.5±0.5mm  
 Operating Force:200±100gf  
 Mechanical Life: Over 50,000 cycles  
 Electrical Life: Over 10,000 cycles  
 Operating Temperature:-20°C~70°C  
 Manual welding:350°C for 3 Seconds

**MATERIAL:**

Outer Frame:ABS;  
 Base:ABS ;  
 Actuator:ABS  
 Terminal: Brass,Silver or Tin plated .

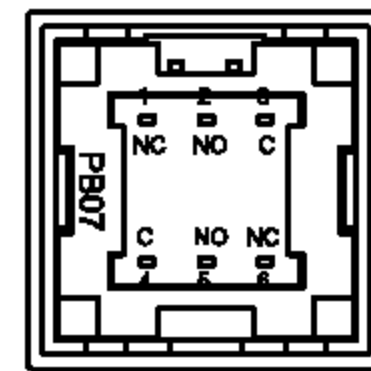
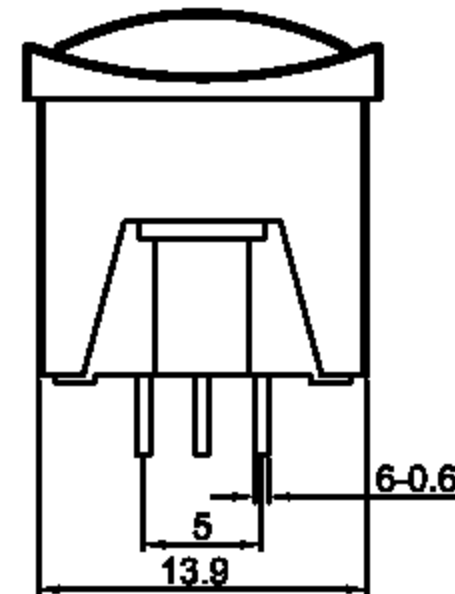
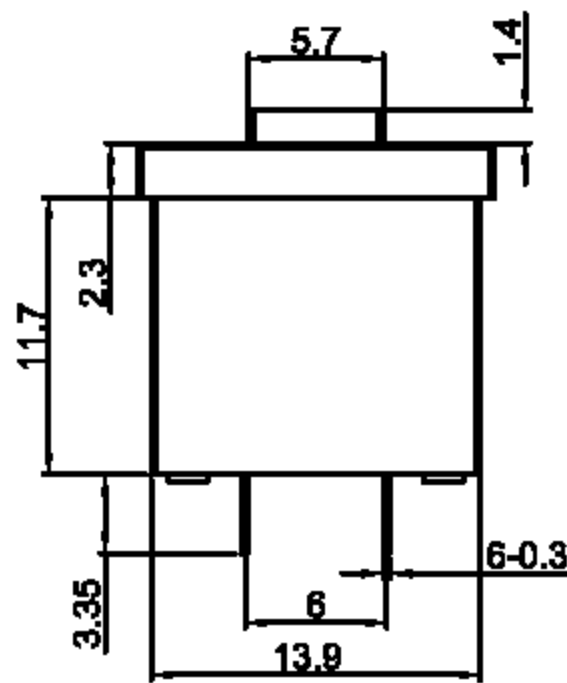

**BOTTOM VIEW**

**Contact Configuration**

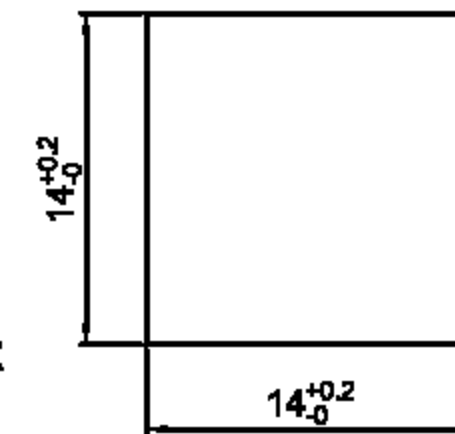
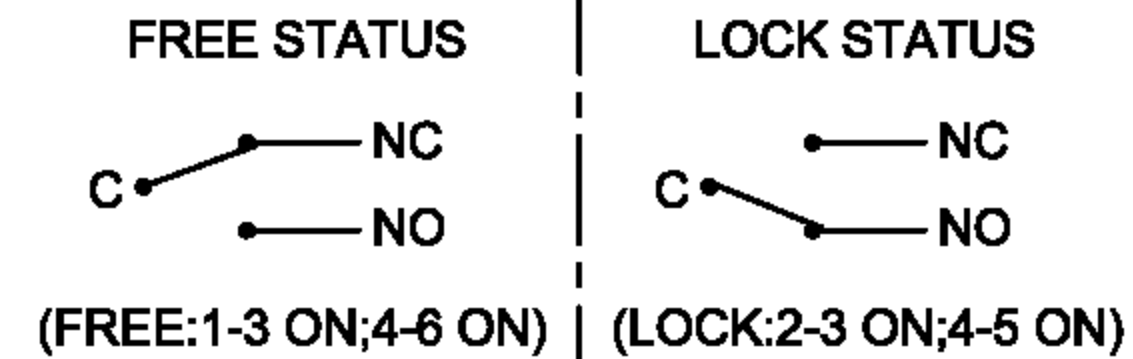

**PANEL HOLE**

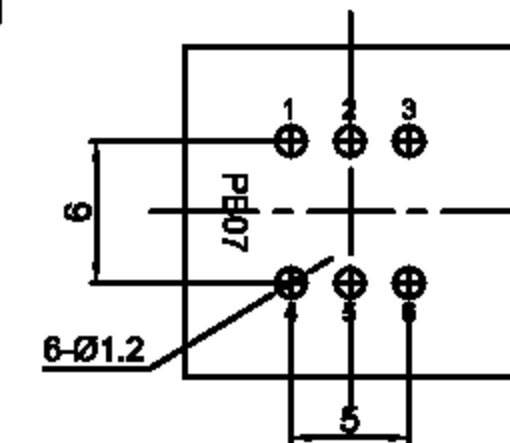

**PCB HOLE(BOTTOM VIEW)**

Y	Yellow	黄色
W	White	白色
U	Blue	蓝色
R	Red	红色
G	Green	绿色
B	Black	黑色
A	Gray	灰色
CAP COLOR (X)		

**Note:**

1.This product is strictly prohibited wave soldering and reflow soldering,please use the manual welding processing, temperature of 350°±5°and time is 3±0.5 seconds;  
 2.After the product is welded on the PCB board,it is prohibited to use any solvent to clean the PCB board,and avoid the influence of the inner product.

				公差 TOLERANCES		.X±0.3 .XX±0.15		角度 ANGLE ±1°		单位 DIMENSION UNIT mm.	
A1	增加产品焊锡说明	2016.10.07	N/A	视角 VIEWING ANGLE		比例尺 SCALE	NONE	日期 DATE	2016.10.07	品名 TITLE	图号 DRAWING NO
A0	New Issue	2011.12.08	N/A	核准	Richard	核对	Sinc	绘图	姜庆勇		
版本 VBR.	变更说明 CHANGE DESCRIPTION	日期 DATE	ECN NO.	APPROVED BY		CHECKED BY		DRAWN BY			