

ROHS

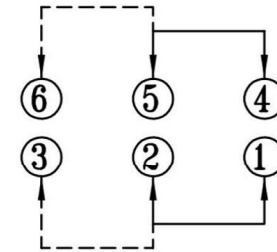

SCHEMATIC (NON-SHORTING)

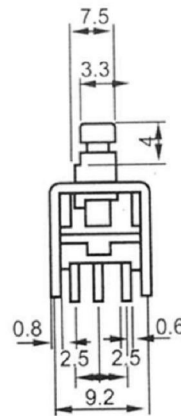
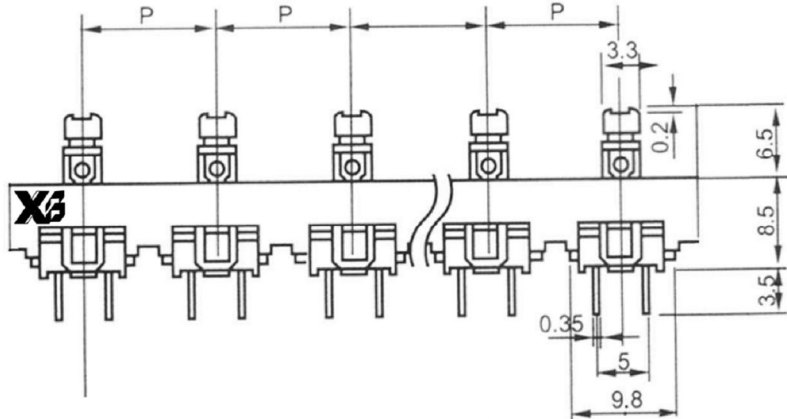
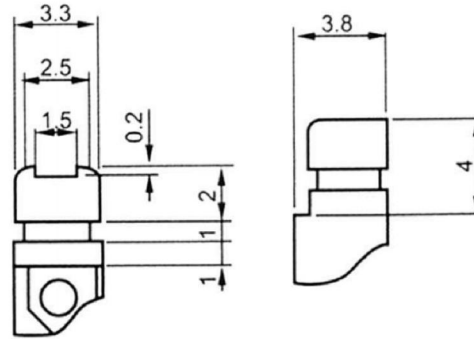
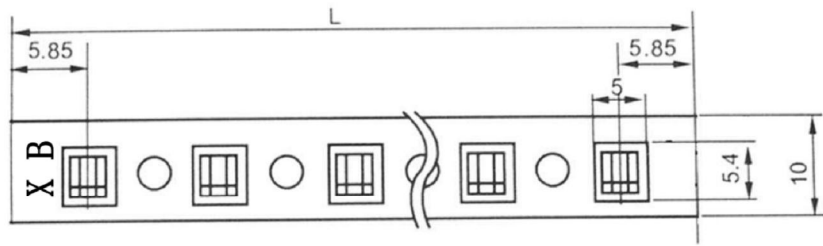
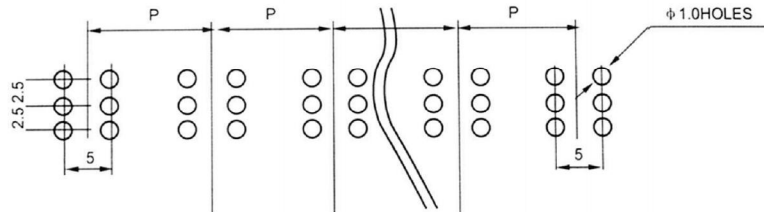

PCB LAYOUT

$P=12.5/15/20/25/30.....$

$L=p+(5.85 \times 2)$

SPECIFICATION (INITIAL)

RATING:	DC 50V 0.5A
CONTACT RESISTANCE:	Not more than 30mΩ
INSULATION RESISTANCE:	500MΩ at 500V DC
WITHSTAND VOLTAGE:	AC 500V for 1 min
OPERATION FORCE:	250gf ±50gf
SWITCHING LIFE:	10K Cycles(6-10c/m loading)

The material contained in this drawing is the property of XiBang. Any use other than that specifically authorized by XiBang is prohibited. The above drawing IS subjected to change for improvement without prior notice.



东莞市溪榜电子有限公司
DONG GUAN XI BANG ELECTRONICS CO., LTD

TITLE : XB Puhs Button switch
MODEL :XB-PB-1028-P125 互动琴键开关8联 互动按键开关8位

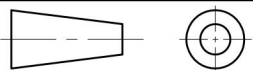

UNIT : MM	DWN.	ZENQ. CHEN	DATE	
SCALE : 2 : 1	CHK'D	DONG. PANG	DATE	
VERSION	01	APPD.	FEI. LONG. HE	DATE

TOLERANCE	ANGLE TOL
<=1.5mm ± 0.1	± 2°
> 1.5mm ± 0.2	
>=10.0mm ± 0.3	

7	HOOK NEEDLE	STEEL WIRE	1	NATURAL
6	SPRING	STEEL WIRE	1	NATURAL
5	CONTACT	PBS	1	Ag PLATED
4	TERMINAL	BRASS STRIP	6	Ag PLATED
3	CASE	NYLON	1	BLACK
2	COVER	NYLON	1	BEIGE
1	KNOB	POM	1	WHITE
NO.	PART NAME	MATERIAL	QTY.	FINISHING