

ROHS

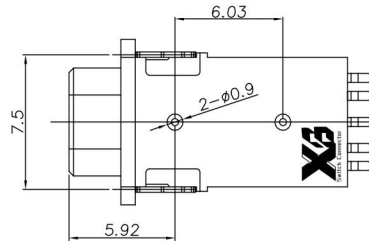

		REVISIONS					
REV.	ECN NO.	LOCATION	DESCRIPTION	DATE	DESIGN	CHECKED	APPROVED
X1							

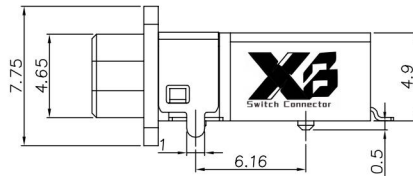
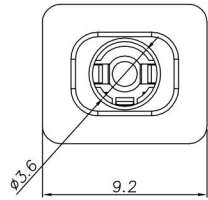
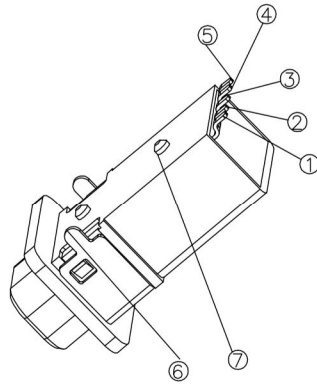
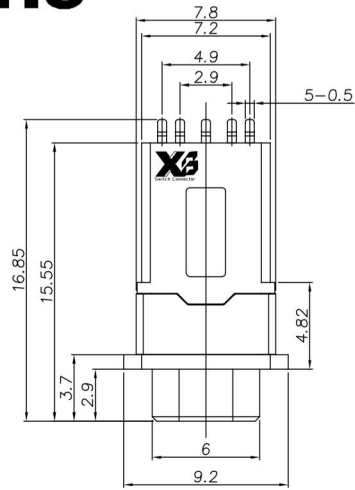
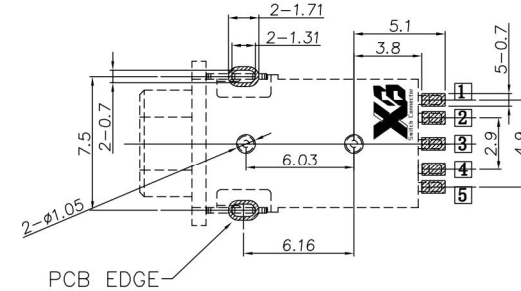
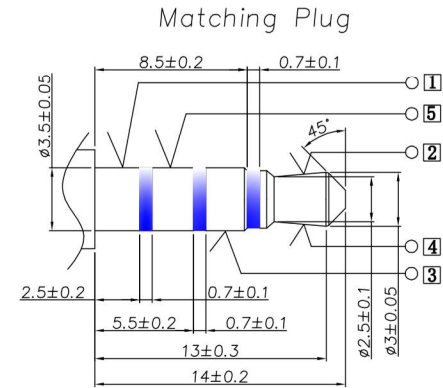

RECOMMENDED P. C. B LAYOUT
TOP VIEW (TOLRANCE: ±0.05)

SPECIFICATION:

1. Electrical characteristics

- 1-1. Current rating: DC 0.5A max.
- 1-2. Voltage rating: DC 30V.

1-3: Contact resistance: 50mΩ max

- 1-4. Insulation resistance: 1000M Ω min. at 500V DC.
- 1-5. Withstanding voltage: 500V AC for 1 minute.

2. Mechanical characteristics

- 2-1. Life test: 5000 cycles min,
- 2-2. Mating force: 3~30N,
Unmating force: 3~30N.

3. Temperature range: -40° C~+80° C

4. Dustproof and waterproof grade: IP67

NO.	DESCRIPTION	QTY	MATERIAL	REMARK
7	塑胶外壳	1	PA9T	Black
6	插脚	1	SUS304-1/2H 0.3t	镀镍
5	5#脚	1	C5210-EH T=0.2	全区镀金1"u"
4	4#脚	1	C5210-EH T=0.2	全区镀金1"u"
3	3#脚	1	C5210-EH T=0.2	全区镀金1"u"
2	2#脚	1	C5210-EH T=0.2	全区镀金1"u"
1	1#脚	1	C5210-EH T=0.2	全区镀金1"u"

MEASURE POINT: (xx)
QUADRANT POINT (QP)
TANGENCY POINT (TP)
INTERSECTION POINT (IP)

UNLESS OTHERWISE SPECIFIED, TOLERANCE:
X. ±0.20
X.x ±0.15
X.xx ±0.10
X.xxx ±0.05
ANGULAR ±2°



东莞市溪榜电子有限公司
DONG GUAN XI BANG ELECTRONICS CO., LTD

DESIGN	GAO PENG	DATE	2012/02/19
CHECKED	HE. LONG. FEI	DATE	
APPROVED	PANG. DONG	DATE	
PART NO.	XB-PJ-32545N-H-IPX7		
DRAWING			

TITLE:	PHONE JACK ASSEMBLY DRAWING		
REV.:	X1	SCALE:	1:1
UNIT:	mm	SHEET:	1/1