

REV.	BCN. NO.	APPD.

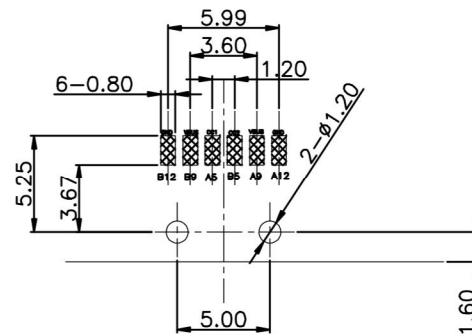

Recommended P.C.B. Layout
Unspecified tolerance: ±0.05
(top view)

由 Autodesk 教育版产品制作

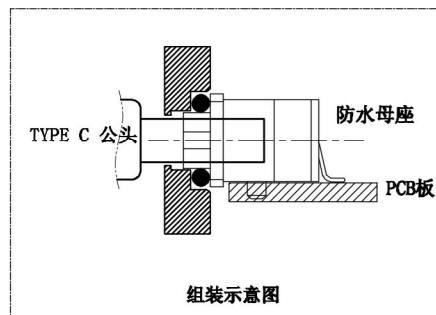
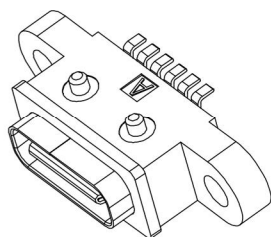
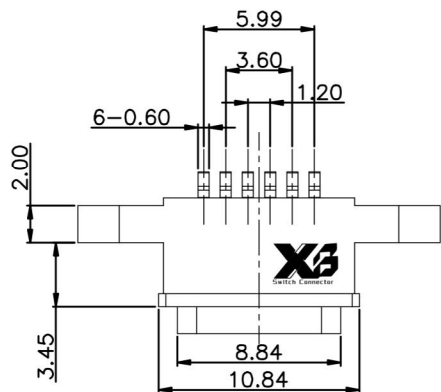
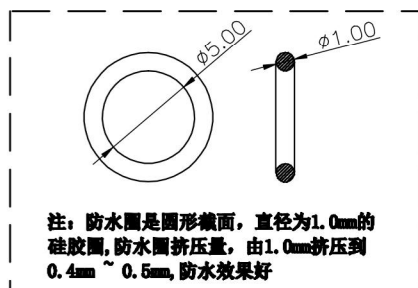
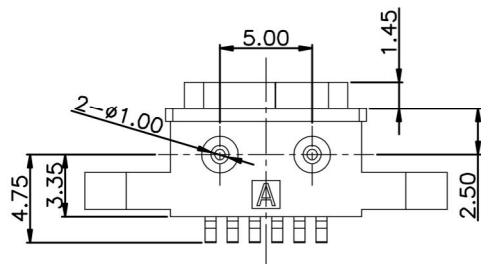
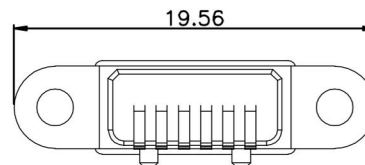
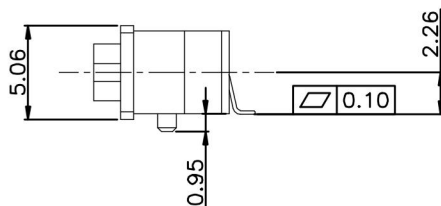
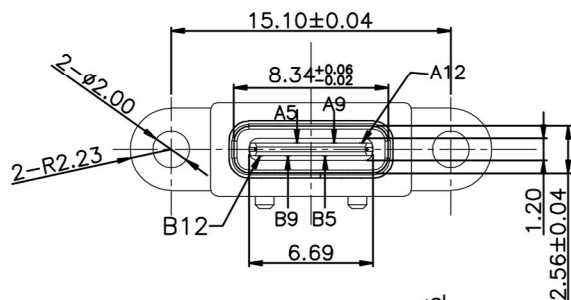

NOTES:

SPECIFICATION:

1. CURRENT RATING: 3.0A MAX
2. DIELECTRIC WITHSTAND VOLTAGE: 100VAC
3. TEMPERATURE RANGE: -30 °C ~ 85 °C
4. CONTACT RESISTANCE: 40 MILLIONHM MAX
5. INSULATION RESISTANCE: 100 MEGOHMS MIN.
6. INSERTION FORCE : 5N~20N
7. UNMATING FORCE: 8N~20N
8. DURABILITY:5,000 CYCLES

由 Autodesk 教育版产品制作

A5	CC1	B12	GND
A9	VBUS	B9	VBUS
A12	GND	B5	CC2
PIN	SIGNAL NAME	PIN	SIGNAL NAME

5	Shell2	1	SUS301 Ni Plating T=0.20mm	Ni:40~120u";
4	Shell1	1	SUS301 Ni Plating T=0.25mm	Ni:40~120u";
3	Housing2	1	LCP(G.F30%)	
2	Contact	5	Phosphor bronze_C5210R-EH Au/Ni Plating T=0.20mm	Ni:40~160u"; Au:CONTACT AREA:3u", OTHER AREA:G/F
1	Housing	1	PA9T (G.F30%)	
ITEM	PART NAME	Q'TY	FINISH	NOTE

X.	± 0.50	X. °	± 2°	UNITS	mm
.X	± 0.30	.X °	± 1°		
.XX	± 0.10	.XX °	± 0.5°	MAT*L	
.XXX	± 0.05			FINISH	
				Q'TY	

X3 东莞市溪榜电子有限公司
DONG GUAN XI BANG ELECTRONICS CO., LTD

PART NO. XB-USB-C-6P-1103A-IPX7

TITLE: TYPE C 6Pin SMT Type

APPD: GAO. PENG

CHKD: HE. LONG. FEI

DR: PANG. DONG

DWG NO.: XB-USB-C-6P-1103A-IPX7

SCALE	SHEET	REV.
1/1	1/2	A1