

# ROHS

REV.	Q'TY	ECN. NO.	REASON&CONTENTS	SIGN	DATE
			New release.	GAO. PENG	2018.01.30

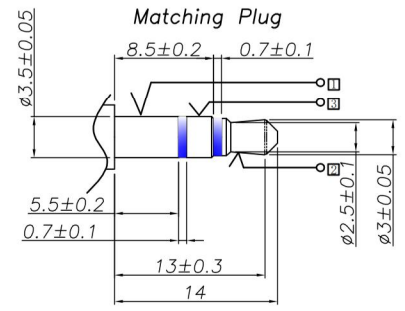
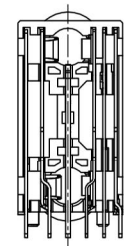
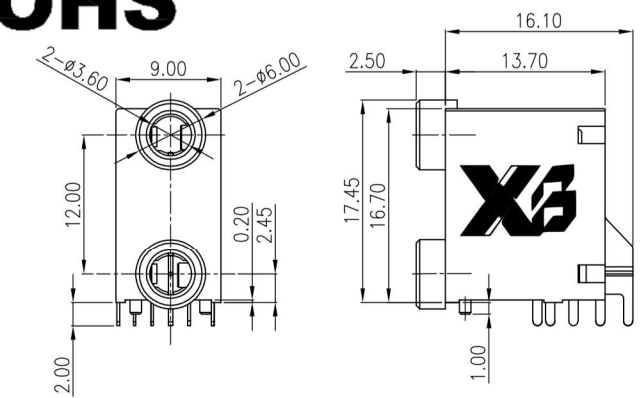

Ordering information:  
**XB-PJ32290 - □□□0A 2 00 3**  
 (1) (2) (3) (4) (5) (6) (7)

(1):Series No.  
 (2):Schematic option:R,D  
 (3):Material of housing:  
 PB=PBT, 9T=PA9T, 10=PA10T  
 (4):Housing color:  
 Zero 0A=Black  
 (5):Terminal plating:  
 2=2u'' gold plating on mating area,  
 50u'' Ni underplating,  
 for contact **1 3 5 6 7 8 9 10 11** ,  
 120u'' matte tin on solder tail  
 for contact **2 4** ,Gold Flash on solder tail.  
 (6):Special option:  
 00=No special option  
 (7):Packing mode:  
 3=Plastic box packing

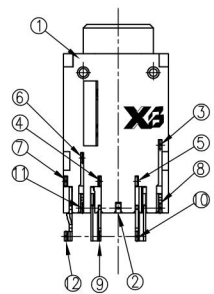
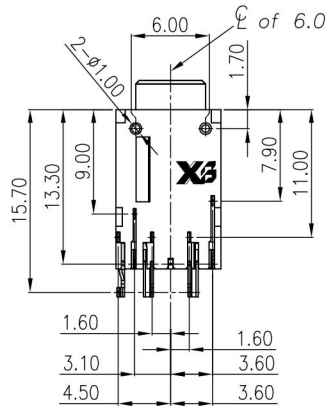

Model No.	PJ32290-R	PJ32290-D
Schematic code		

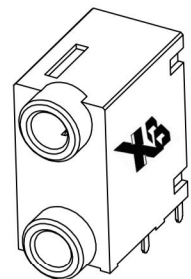
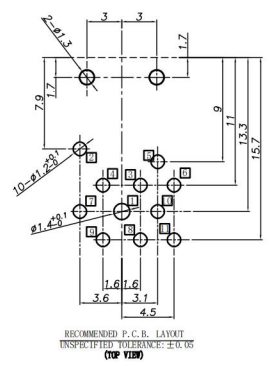

Specification:  
 1. Rating : DC 30V 0.5A;  
 2. Contact resistance: ≤30mΩ;  
 After test: ≤50mΩ  
 3. Insulation resistance: ≥100MΩ (500VDC);  
 After test: ≥50MΩ  
 4. Withstand voltage: 500VAC ;  
 5. Insertion and extraction force: 3N~30N;  
 6. life test: 5000cycles min;  
 7. Operation temperature range: -20℃~70℃;  
 8. Preservation temperature range: -40℃~85℃;

12	Transfer terminal	11	1	Phosphor bronze	2u'' Au / Tin 120u'' / Ni 50u''
11	Break terminal	10	1	Brass	2u'' Au / Tin 120u'' / Ni 50u''
10	Shunt terminal	9	1	Brass	2u'' Au / Tin 120u'' / Ni 50u''
9	Ring spring	8	1	Phosphor bronze	2u'' Au / Tin 120u'' / Ni 50u''
8	Tip spring-2	7	1	Phosphor bronze	2u'' Au / Tin 120u'' / Ni 50u''
7	Transfer terminal-1	6	1	Phosphor bronze	2u'' Au / Tin 120u'' / Ni 50u''
6	Break terminal-1	5	1	Brass	2u'' Au / Tin 120u'' / Ni 50u''
5	Shunt terminal-1	4	1	Brass	2u'' Au / Ni 50u''
4	Ring spring-1	3	1	Phosphor bronze	2u'' Au / Tin 120u'' / Ni 50u''
3	Tip spring-1	2	1	Phosphor bronze	2u'' Au / Ni 50u''
2	Earth spring	1	1	Phosphor bronze	2u'' Au / Tin 120u'' / Ni 50u''
1	Housing		1	PA9T/PA10T	

NO.	DESCRIPTION	QTY	MATERIAL	Mating area plating spec
UNIT: MM		TYPE:		MODEL NO:
PAPER NO: A4		PAGE 1 OF 1		
TOLERANCE		ANGLES		SCALE
±0.3		±2'		N/A
VER				01

DESIGNER BY:  
 CHECK BY:  
 APPROVED BY:

