

CAD FILE:

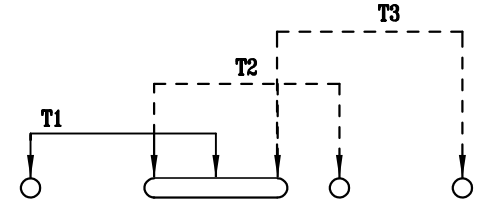

SCHEMATIC

P.C.B LAYOUT
BOTTOM VIEW

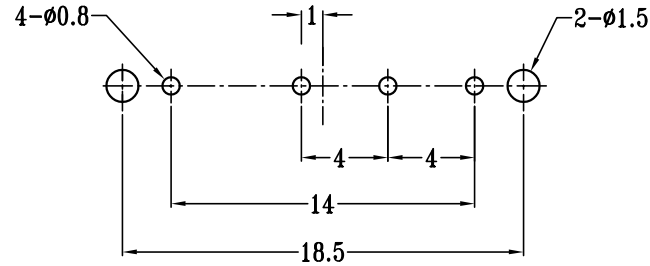
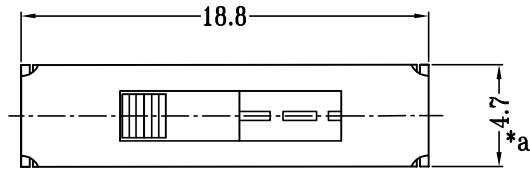
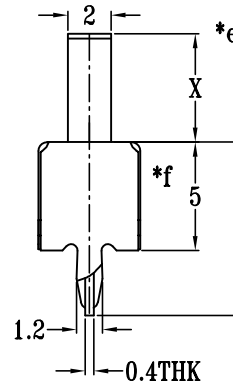
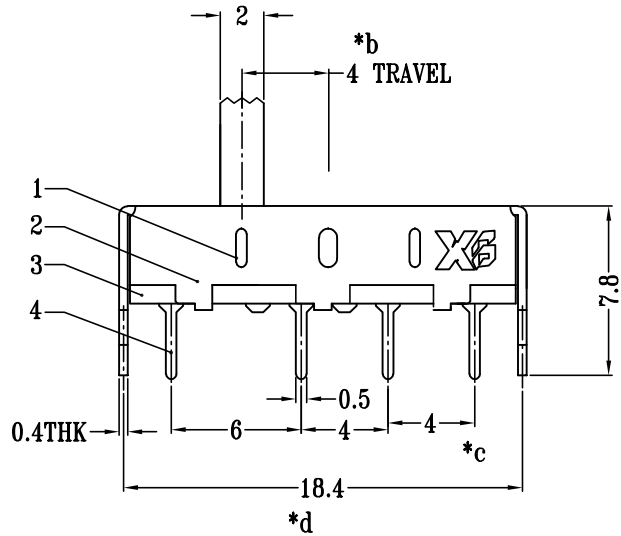

无唛

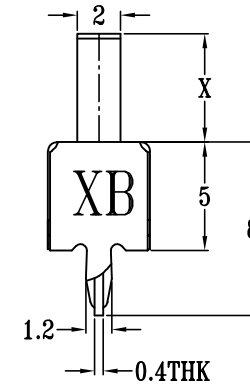

XB唛

注：“*”表示关键尺寸（6个）

NO.	PARTS	MATERIALS	Q'TY	FINISH	TOLERANCE UNLESS SPECIFIED				DESCRIPTIONS OF REVISION		
8					WITHIN 1.5mm	±0.1mm	A/0	2024-5-24			
7					OVER 1.5mm	±0.2mm	ISSUE	DATE			REMARK
6	SPRING PLATE	SUS304	1	NATURAL	TITLE : HORIZONTAL SLIDE SWITCH			UNIT : mm	DRWG NO.: XB-SS-13H12X		
5	CONTACT CLIP	C5210R	1	Ag CLAD	MODEL: XB-SS-13H12X			SCALE: 3:1	DWN.	高鹏	2024-7-8
4	TERMINAL	C2680R	6	Ag PLATED	 东莞市溪榜电子有限公司 DONG GUAN XI BANG ELECTRONICS CO., LTD.			CHK'D	庞东	2024-7-8	
3	BASE	PHENOLIC RESIN	1	NATURAL				APPD.	贺龙飞	2024-7-8	
2	FRAME	SPCC	1	Sn PLATED							
1	KNOB	PA66	1	BLACK							