



**XB-FPC-1001 S V 55 -XX X XX 01**

**XB connector**  
**Series No**  
**Termipoint** S-SMT  
**Angle** V-180°  
**Height** 55-5.50mm

**Contact**  
 01-A Type (Bottom Contacts)  
 02-B Type (Top Contacts)

**Terminal Plating**  
 11-All G/F  
 MT-Matte Tin  
 BT-Bright Tin

**Housing Colour**  
 S-Nature

**Pin Q' PY**  
 04~40

**XB-FPC specifications:**

1. Current rated: 0.5A AC/DC
2. Voltage rating: 50V AC/DC
3. Withstanding voltage: 250V AC
4. Contact resistance: 30mΩ max.
5. Insulation resistance: 500MΩ min
6. Durability cycle: 20Cycles
7. Removal force: 0.03kgf/Pin min
8. Operating temperature range: -25°C ~ +85°C

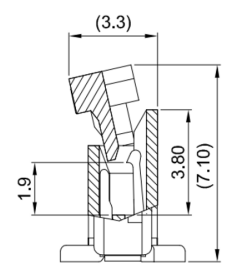
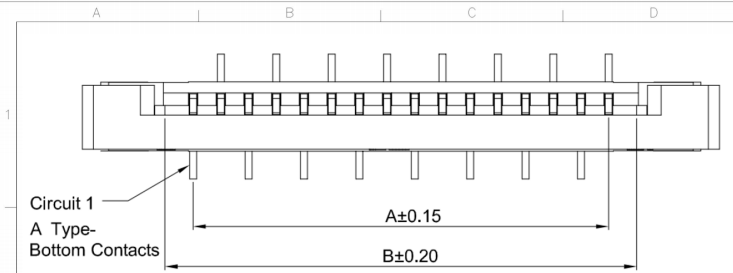

SECTION: A-A

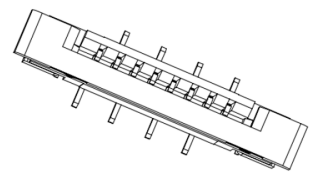
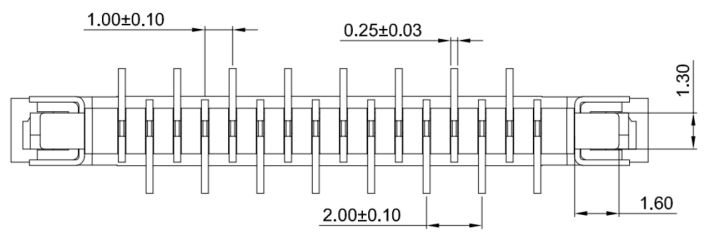
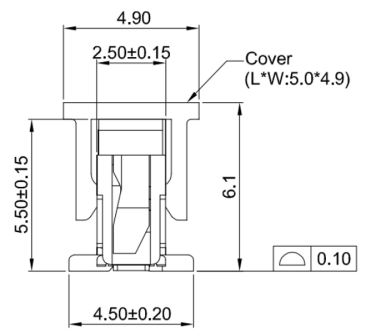
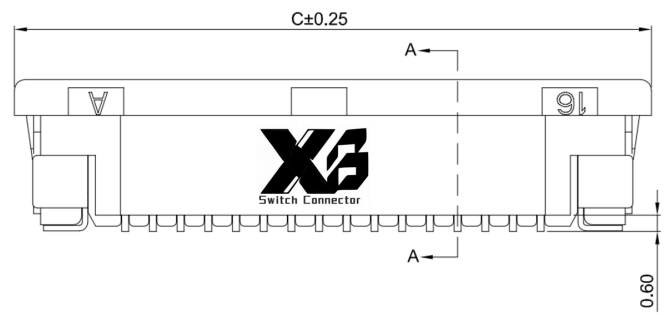

**XB** 东莞市溪榜电子有限公司  
 DONG GUAN XI BANG ELECTRONICS CO., LTD.

TOLERANCE UNLESS OTHERWISE STATED:  
 Up to 5 ±0.2  
 Above 5 ~ 15 ±0.3  
 Above 15 ~ 30 ±0.4  
 Above 30 ~ 50 ±0.5  
 Angle ±0.3°

3RD. ANGEL'S

DRAWN BY: Jack Lu DATE: 03/10/22  
 CHECKED BY: Jacky Chen DATE: 03/10/22  
 APPROVED BY: Tony Kao DATE: 03/10/22

MAT'L		TITLE	CONNECTOR
FINISH		MODLE	FPC 1.00mm Pitch 180° H5.50mm SMT Type Bottom Contacts Connector
SCALE	1 : 1	DWG NO.	XB-FPC-1001SV55-XXXXX01
SHEET NO.	1 of 1	PART NO.	

1	更新圖面	Jack	031022
ITEM NO.	DESCRIPTION	DRAWN	DATE

SIZE	A4
VER	R1



**Ordering Information:**

Circuit	Dimensions(mm)		
	A	B	C
4P	3.00	5.03	11.10
5P	4.00	6.03	12.10
6P	5.00	7.03	13.10
7P	6.00	8.03	14.10
8P	7.00	9.03	15.10
9P	8.00	10.03	16.10
10P	9.00	11.03	17.10
11P	10.00	12.03	18.10
12P	11.00	13.03	19.10
13P	12.00	14.03	20.10
14P	13.00	15.03	21.10
15P	14.00	16.03	22.10
16P	15.00	17.03	23.10
17P	16.00	18.03	24.10
18P	17.00	19.03	25.10
19P	18.00	20.03	26.10
20P	19.00	21.03	27.10
21P	20.00	22.03	28.10
22P	21.00	23.03	29.10
23P	22.00	24.03	30.10
24P	23.00	25.03	31.10
25P	24.00	26.03	32.10
26P	25.00	27.03	33.10
27P	26.00	28.03	34.10
28P	27.00	29.03	35.10
29P	28.00	30.03	36.10
30P	29.00	31.03	37.10
31P	30.00	32.03	38.10
32P	31.00	33.03	39.10
33P	32.00	34.03	40.10
34P	33.00	35.03	41.10
35P	34.00	36.03	42.10
36P	35.00	37.03	43.10
37P	36.00	38.03	44.10
38P	37.00	39.03	45.10
39P	38.00	40.03	46.10
40P	39.00	41.03	47.10

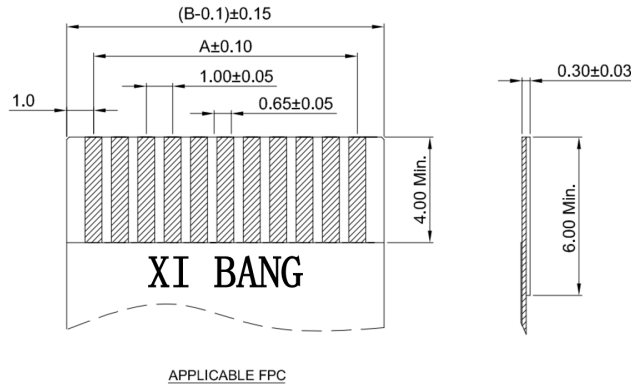
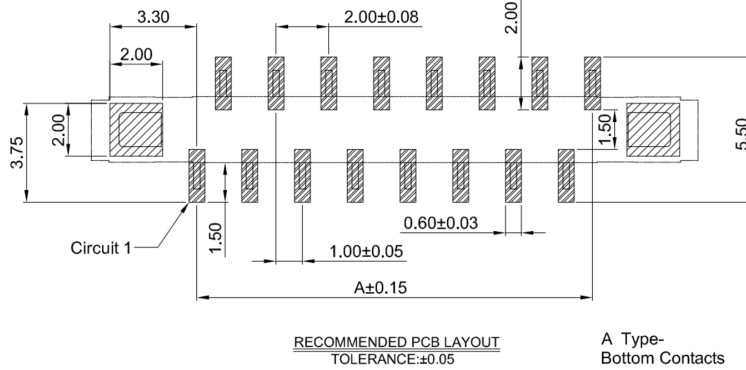

**XB-FPC-1001 S V 55 -XX X XX 01**

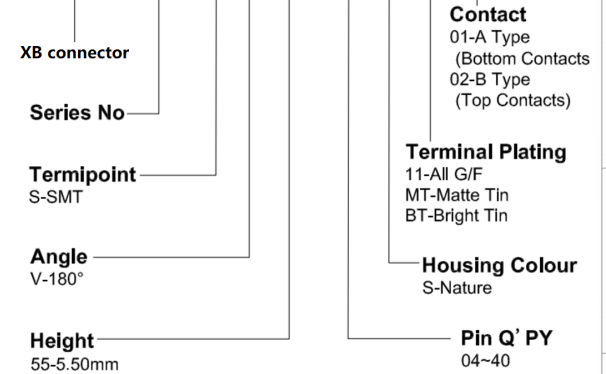

**XB-FPC specifications:**

1. Current rated: 0.5A AC/DC
2. Voltage rating: 50V AC/DC
3. Withstanding voltage: 250V AC
4. Contact resistance: 30mΩ max.
5. Insulation resistance: 500MΩ min
6. Durability cycle: 20Cycles
7. Removal force: 0.03kgf/Pin min
8. Operating temperature range: -25°C ~ +85°C



TOLERANCE UNLESS OTHERWISE STATED:

Up to 5 ±0.2  
Above 5 ~ 15 ±0.3  
Above 15 ~ 30 ±0.4  
Above 30 ~ 50 ±0.5  
Angle ±0.3°

3RD. ANGEL'S



UNITS

MM

DRAWN BY:	DATE	MAT'L	TITLE	CONNECTOR
Jack Lu	03/10/22	FINISH	MODLE	FPC 1.00mm Pitch 180° H5.50mm SMT Type Bottom Contacts Connector
CHECKED BY:	DATE	SCALE	DWG NO.	XB-FPC-1001SV55-XXXXX01
Jacky Chen	03/10/22	1 : 1	PART NO.	
APPROVED BY:	DATE	SHEET NO.	1 of 1	
Tony Kao	03/10/22			

ITEM NO.	DESCRIPTION	DRAWN	DATE
1	更新圖面	Jack	031022

SIZE
A4
VER
R1