

1 2 3 4 5 6 7 8 9

F

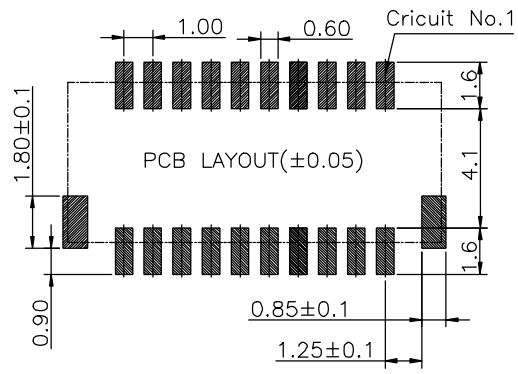
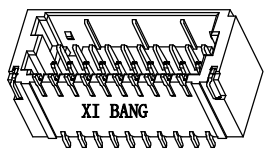
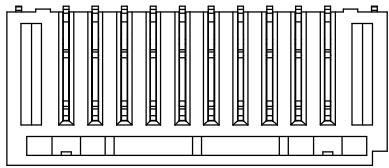

Specifications
 Current Rating:1Amp
 Insulation Resistance:100MΩ Min.
 Dielectric Withstanding Voltage:500VAC
 Contact Resistance:30mΩ Max.
 Operating Temperature:-25°C to +85°C
 Materials
 Contact Material:Phosphor Bronze
 Insulator Material: UL 94V-0 PA9T
 All materials must meet XI BANG hazardous substances control standards.

E

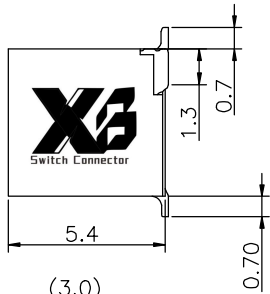
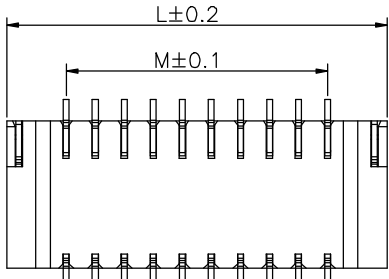

D

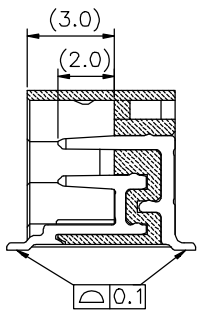
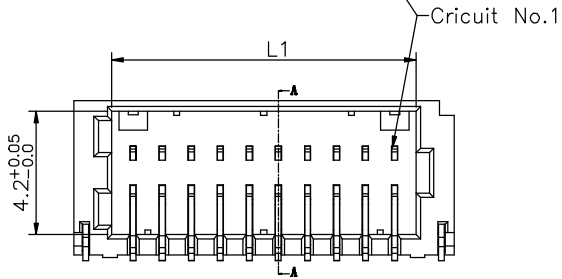

Pins	M	L1	L
06	5.0	6.5	9.1
08	7.0	8.5	11.1
10	9.0	10.5	13.1
15	14.0	15.5	18.1
20	20.0	20.5	23.1
25	25.0	25.5	28.1

C

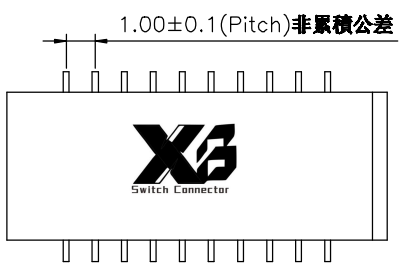

A-A

Ordering Information

XB-X10-PCB-202-A003 - XX XX A 003 D X A X

No. of Pins per Row SEE TABLE
 Standard Plating 02=Gold Flash
 Selective Plating 05=Gold Flash/Tin
 Color 2=White
 Standard Packing D=Tape&Reel

A

东莞市溪榜电子有限公司
 DONG GUAN XI BANG ELECTRONICS CO., LTD

REV. A UNIT. mm SCALE. 1:1 PAGE. 1/1

GENERAL TOLERANCE	
X'±3.0'	X.±
.X'±1.0'	.X±0.25
.XX'±	.XX±0.15
.XXX'±	.XXX±0.10

DESIGNED:
 CHECKED:
 APPROVED:

DATE:
 DATE:
 DATE:

DWG. NO.
 XB-X10-PCB-202-A003
 PART NO.

TITLE.
 1.0 WTB CONN,SMT SINGLE ROW RIGHT-ANGLE

1 2 3 4 5 6 7 8 9

1 2 3 4 5 6 7 8 9

F

F

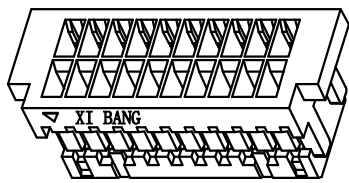
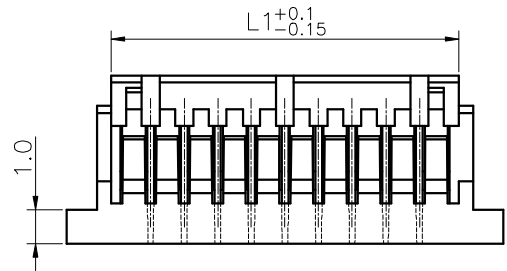

Specifications
 Operating Voltage:50V AC/DC
 Current Rating:1Amp(28#)
 Insulation Resistance:100MΩ Min.
 Dielectric Withstanding Volatge:500VAC
 Contact Resistance:30mΩ Max.
 Operating Temperature:-25°C to +85°C
 Materials
 Material:PBT UL94V-0
 All materials must meet XI BANG
 hazardous substances control standards.

E

E

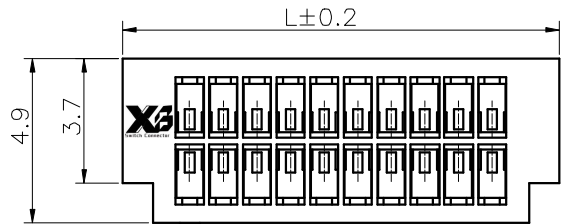

D

D

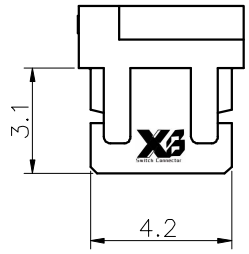
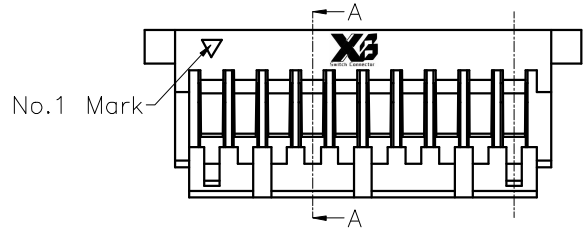
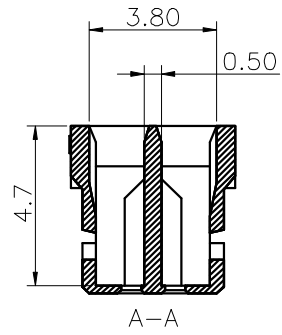

C

C

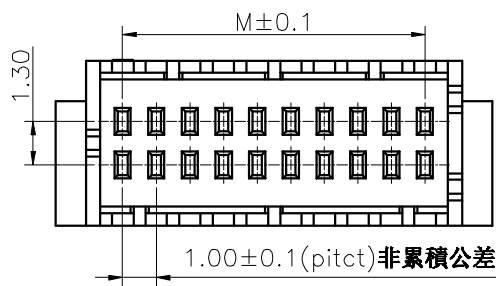

Ordering Information

XB-X10-PCB-202-A003M - XX A XX

No. of Pins/Row: 06, 08, 10, 15, 20, 25
 Material/Color: E=PBT/White

No. of Pins	M	L1	L
06	5.0	6.4	9
08	7.0	8.4	11
10	9.0	10.4	13
15	14.0	15.4	18
20	19.0	20.4	23
25	24.0	25.4	28

A

A

东莞市溪榜电子有限公司
 DONG GUAN XI BANG ELECTRONICS CO., LTD

REV. A UNIT. mm SCALE. 1:1 PAGE. 1/1

GENERAL TOLERANCE	
X:±3.0'	X.±
.X'±1.0'	.X±0.25
.XX'±	.XX±0.15
.XXX'±	.XXX±0.10

DESIGN:
 CHECKED:
 AUDITED:

DATE:
 DATE:
 DATE:

DWG. NO.
 XB-X10-PCB-202-A003M
 PART NO.

TITLE:
 SHD 1.0mm pitch
 Dual row HSG

1 2 3 4 5 6 7 8 9

1 2 3 4 5 6 7 8 9

F

E

D

C

B

A

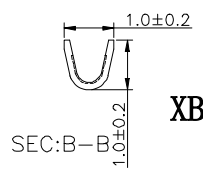
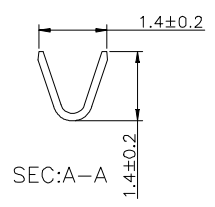
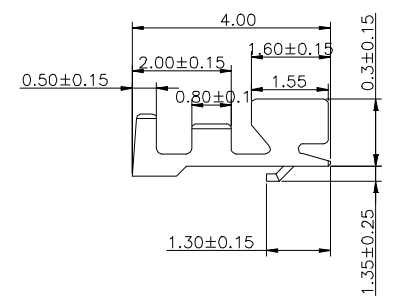
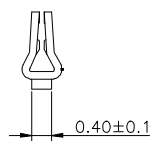
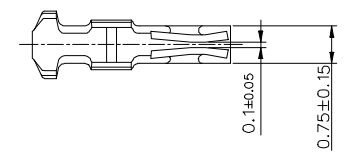
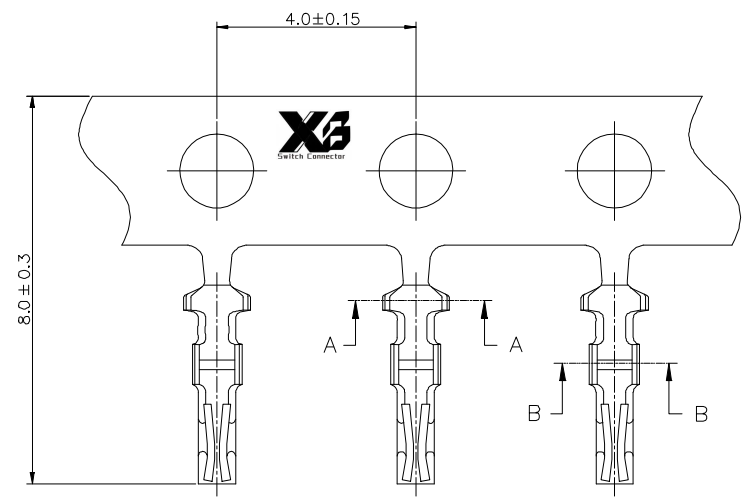

Ordering Information

XB-X10-PCB-202-A003D- 02 XX AB

Standard Plating
01=Tin

RATING
 OPERATING TEMPERATURE: -25~85°C
 OPERATING VOLTAGE: 150V AC/DC
 CURRENT RATING: 1.0 AMPS
 DIELECTRIC WITHSTANDING VOLTAGE:
 800V AC/Minute;
 INSULATION RESISTANCE: 1000MΩ Min;
 CONTACT RESISTANCE: 0.03Ω Max;

东莞市溪榜电子有限公司
 DONG GUAN XI BANG ELECTRONICS CO., LTD

REV. **B** UNIT. mm SCALE. 1:1 PAGE. 1/1

GENERAL TOLERANCE	
X.* ± 5.0°	X. ± 0.30
.X* ± 3.0°	.X ± 0.25
.XX* ± 2.0°	.XX ± 0.15
.XXX* ± 1.0°	.XXX ± 0.10

DESIGNED:
CHECKED:
APPROVED:

DATE:
DATE:
DATE:

DWG. NO.
XB-X10-PCB-202-A003D
PART NO.

TITLE.
1.0T-端子

1 2 3 4 5 6 7 8 9