

ROHS

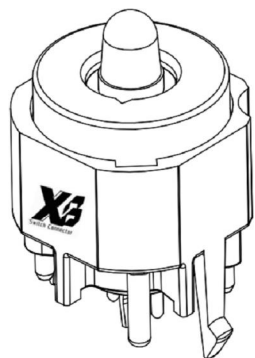

P.C.B. LAYOUT

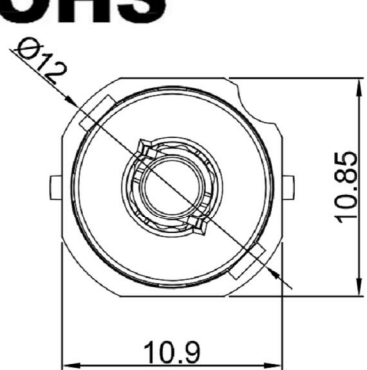
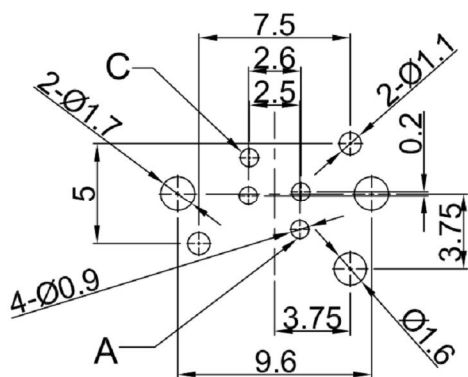

SPECIFICATIONS

Circuit	:SPST
Current rating	:10mA min./100mA max.
Voltage rating	:2V DC min./30V DC max.
Dielectric withstanding voltage	:500VAC for 1 minute
Contact resistance	:50mΩ Max. (Initial)
Insulation resistance	:100MΩ Min.
Operating force	:500± 100gf
Total travel	:1.5± 0.4mm
Operating life:	:1,000,000 cycles Min
Bounce time:	: ≤ 1ms
Operating speed	100 mm/s(3.94/s)
Solder specifications	:260° C for 5 seconds
Operating temperature	:- 40° C ~ + 85° C
Protection class	: IP40

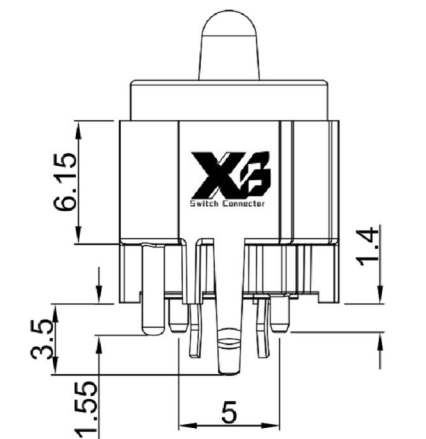
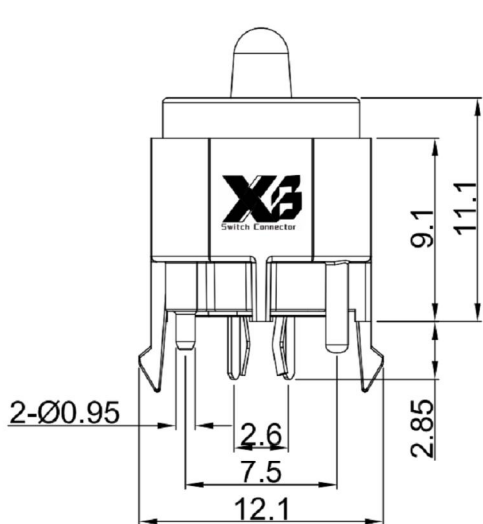

CIRCUIT

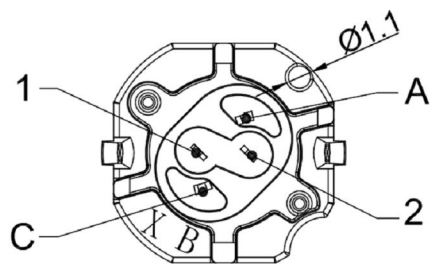
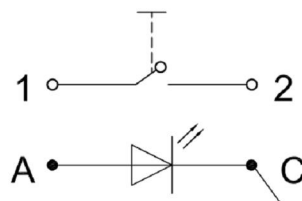

MATERIAL:

Base : PA+GF,UL rated:94 V-2 Min;
Cap: POM ;
Terminal: Brass,Gold plated;

LED SPECIFICATIONS

G1	Bright Green 翠绿色	2.8	3.0	3.4	20
W	White 白色	2.8	3.0	3.4	20
U	Blue 蓝色	2.8	3.0	3.4	20
Y	Yellow 黄色	1.8	2.0	2.4	20
G	Green 黄绿色	1.8	2.0	2.4	20
R	Red 红色	1.8	2.0	2.4	20
灯发光颜色(X)		最小	一般	最大	最大操作电流
Emitted Color (X)		顺向电压(V)			(mA)



东莞市溪榜电子有限公司
DONG GUAN XI BANG ELECTRONICS CO., LTD

TITLE : XB TACT SWITCH

MODEL : XB-PBS-12-PL1.5-BBR-5N-S



TOLERANCE
≤1.5mm ± 0.1
> 1.5mm ± 0.2
>=10.0mm ± 0.3

ANGLE TOL
± 2°

UNIT : MM	DWN.	ZENQ. CHEN	DATE	
SCALE : 5 : 1	CHK'D	PENG. GAO	DATE	
VERSION	01	APPD.	FEI. LONG. HE	DATE

8	REEL	PS	1	BLUE
7	CARRIER	PS	1	CLEAR
6	COVER TAPE	PS	1	CLEAR
5	CONTACT	PBS STRIP	1	Ag CLAD
4	COVER	IRON STRIP	1	Ni PLATED
3	CASE	NYLON	1	BLACK
2	TERMINAL	BRASS STRIP	2	Ag PLATED
1	KNOB	NYLON	1	BLACK
NO.	PART NAME	MATERIAL	QTY.	FINISHING